

# 19

THORACIC & LUNG SURGERY

[www.crimson-intl.com](http://www.crimson-intl.com)



INTERNATIONAL  
**CRIMSON**<sup>™</sup>

- EN Thoracic & Lung Surgery
- DE Brust und Lungenchirurgie
- ES Cirugía torácica y pulmonar

**CRIMSON INTERNATIONAL**

Paris Road Block # 2, Sialkot 51310, Pakistan

Tel: +92.334.6922020

Email: [info@crimson-intl.com](mailto:info@crimson-intl.com) | [sales@crimson-intl.com](mailto:sales@crimson-intl.com)

# 19

- EN Bone and Rib Shears
- DE Knochen-und Rippenscheren
- ES Cizallas para huesos

INTERNATIONAL  
**CRIMSON™**

THORACIC & LUNG SURGERY  
[www.crimson-intl.com](http://www.crimson-intl.com)



**COLLIN**  
19.0010.19 19.0cm



**STILLE**  
19.0020.21 21.0cm



**GLUCK**  
19.0030.19 19.0cm  
19.0030.22 22.0cm



19.0040.20 20.0cm  
19.0040.23 23.0cm



19.0050.22 22.0cm



19.0060.17 17.0cm

19.0060.17

19-001

# 19

- EN Rib Shears, Stenum Scissors, Stenum Chisel
- DE Rippenscheren, Stenummschere, Stenummeißel
- ES Costotomos, tijera de estemon, cincel de estemon

INTERNATIONAL  
**CRIMSON™**

THORACIC & LUNG SURGERY  
[www.crimson-intl.com](http://www.crimson-intl.com)



19.0120.26  
**19-002**

# 19

- EN Bone and Rib Shears
- DE Knochen-und Rippenscheren
- ES Cizallas para huesos y costillas

INTERNATIONAL  
**CRIMSON™**

THORACIC & LUNG SURGERY  
[www.crimson-intl.com](http://www.crimson-intl.com)



19.0132.35 35.0cm

**CORYLLOS**  
19.0130.35 35.0cm



**BETHUNE**  
19.0140.34 34.0cm



**DOYEN**  
19.0150.19 19.0cm

19.0150.19  
**19-003**



# 19

- EN Bone and Rib Shears
- DE Knochen-und Rippenscheren
- ES Cizallas para huesos y costillas

INTERNATIONAL  
**CRIMSON™**

THORACIC & LUNG SURGERY  
[www.crimson-intl.com](http://www.crimson-intl.com)



**BETHUNE-NELSON**  
19.0160.34 34.0cm  
with probe ended blades



**ROBERTS**  
19.0170.34 34.0cm  
with angular probe ended blades



**ROBERTS**  
19.0180.34 34.0cm  
with angular probe ended  
blades of first and second ribs

19.0180.34

19-004

# 19

- EN Bone and Rib Shears
- DE Knochen-und Rippenscheren
- ES Cizallas para huesos y costillas

INTERNATIONAL  
**CRIMSON™**

THORACIC & LUNG SURGERY  
[www.crimson-intl.com](http://www.crimson-intl.com)



**SCHUMACHER**  
19.0190.21 21.0cm



**TUDOR EDWARDS**  
19.0200.23 23.0cm

19.0200.23

19-005

# 19

- EN** Rib Spreaders
- DE** Rippensperrerr
- ES** Separadores

INTERNATIONAL  
**CRIMSON™**

THORACIC & LUNG SURGERY  
[www.crimson-intl.com](http://www.crimson-intl.com)



CASTAÑEDA		ALU	a	b	c
S/S	19.0300.01	19.7300.01	10.5mm	32mm	65mm
S/S	19.0300.02	19.7300.02	16mm	30mm	65mm



CASTAÑEDA		ALU	a	b	c
S/S	19.0302.01	19.7302.01	12mm	45mm	70mm



CASTAÑEDA		ALU	a	b	c
S/S	19.0304.01	19.7304.01	15mm	60mm	120mm

19.7304.01  
19-006

19

- EN Rib Spreaders
- DE Rippensperrer
- ES Separadores

INTERNATIONAL  
CRIMSON™

THORACIC & LUNG SURGERY  
www.crimson-intl.com

Scheme of dimensions



## COOLEY

SS	ALU	a	b	c
19.0310.01	19.7310.01	12mm	13mm	95mm
19.0310.02	19.7310.02	12mm	17mm	75mm
19.0310.03	19.7310.03	14mm	16mm	65mm



## COOLEY

SS	ALU	a	b	c
19.0312.01	19.7312.01	15mm	30mm	115mm
19.0312.02	19.7312.02	15mm	30mm	140mm
19.0312.03	19.7312.03	18mm	30mm	105mm
19.0312.04	19.7312.04	20mm	45mm	140mm
19.0312.05	19.7312.05	21mm	44mm	150mm
19.0312.06	19.7312.06	30mm	35mm	140mm



## COOLEY

SS	ALU	a	b	c
19.0314.01	19.7314.01	30mm	50mm	185mm
19.0314.02	19.7314.02	35mm	50mm	200mm
19.0314.03	19.7314.03	37mm	48mm	200mm

19.7314.03

19-007

# 19

- EN** Rib Spreaders
- DE** Rippensperrer
- ES** Separadores

INTERNATIONAL  
**CRIMSON™**

**THORACIC & LUNG SURGERY**  
www.crimson-intl.com



**COOLEY**

for neonatal

SIS	ALU	a	b	c
19.0320.01	19.7320.01	12mm	15mm	70mm



**COOLEY**

infant, sternal spreader

SIS	ALU	a	b	c
19.0322.01	19.7322.01	15mm	20mm	100mm



**COOLEY**

for babies

SIS	ALU	a	b	c
19.0330.01	19.7330.01	20mm	25mm	100mm

19.7330.01  
**19-008**

19

- EN** Rib Spreaders
- DE** Rippensperrer
- ES** Separadores

INTERNATIONAL  
**CRIMSON™**

THORACIC & LUNG SURGERY  
www.crimson-intl.com

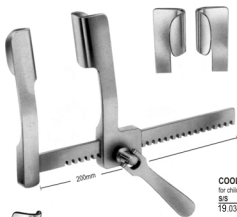
**COOLEY**

for children

S/S	ALU	a	b	c
19.0340.01	19.7340.01	21mm	45mm	145mm

for adult

19.0340.02	19.7340.02	32mm	50mm	190mm
------------	------------	------	------	-------

**COOLEY**

for children

S/S	ALU	a	b	c
19.0350.01	19.7350.01	35mm	100mm	180mm

for adult

19.0350.02	19.7350.02	35mm	115mm	230mm
------------	------------	------	-------	-------

**COOLEY**

for adults with suture separator

S/S	ALU	a	b	c
19.0360.01	19.7360.01	35mm	100mm	180mm

19.7360.01

19-009

# 19

- EN** Rib Spreaders
- DE** Rippensperrer
- ES** Separadores

# INTERNATIONAL CRIMSON™

**THORACIC & LUNG SURGERY**  
[www.crimson-intl.com](http://www.crimson-intl.com)

Scheme of dimensions



**H-COOLEY**

with seivel convex blades, for babies

S/S	ALU	a	b	c
19.0370.01	19.7370.01	10mm	15mm	90mm



**H-COOLEY**

with seivel blades, for babies

S/S	ALU	a	b	c
19.0370.02	19.7370.02	10mm	15mm	90mm



**STRUCK**

for infant

S/S

19.0380.00

consisting of

19.0380.90 spreader only

19.0380.04 1 pair

19.0380.05 1 pair



S/S blades only

19.0380.01

10x10mm

19.0380.02

10x15mm

19.0380.03

10x20mm

19.0380.04

15x20mm

19.0380.05

20x20mm

19.7380.05

19-010

# 19

- EN** Rib Spreaders
- DE** Rippensperrer
- ES** Separadores

INTERNATIONAL  
**CRIMSON™**

THORACIC & LUNG SURGERY  
[www.crimson-intl.com](http://www.crimson-intl.com)

Scheme of dimensions

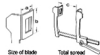

**WEINBERG**

for children

SS	ALU	a	b	c
19.0390.01	19.7390.01	12mm	20mm	95mm



**FINOCHIETTO-INFANT**

SS	ALU	a	b	c
19.0400.01	19.7400.01	12mm	15mm	70mm
19.0400.02	19.7400.02	15mm	15n	75mm

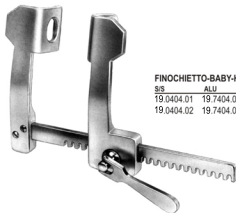

**FINOCHIETTO-BABY-HAIGHT**

SS	ALU	a	b	c
19.0404.01	19.7404.01	27mm	30mm	95mm
19.0404.02	19.7404.02	31mm	31mm	100mm

19.7404.02

19-011



19

- EN** Rib Spreaders
- DE** Rippensperrer
- ES** Separadores

**THORACIC & LUNG SURGERY**  
[www.crimson-intl.com](http://www.crimson-intl.com)

19.7430.05  
**19-012**

INTERNATIONAL  
**CRIMSON™**

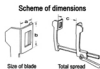
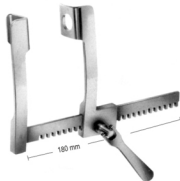
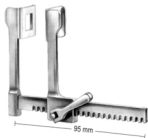

#### FINOCHIETTO-BABY

S/S	ALU	a	b	c
19.0410.01	19.7410.01	14mm	15mm	75mm
19.0410.02	19.7410.02	18mm	20mm	75mm

S/S	ALU	a	b	c
19.0420.01	19.7420.01	28mm	32mm	120mm

#### FINOCHIETTO

S/S	ALU	a	b	c
19.0430.01	19.7430.01	12mm	15mm	100mm
19.0430.02	19.7430.02	28mm	30mm	143mm
19.0430.03	19.7430.03	31mm	45mm	210mm
19.0430.04	19.7430.04	42mm	61mm	245mm
19.0430.05	19.7430.05	74mm	64mm	245mm

# 19

- EN** Rib Spreaders
- DE** Rippensperrerr
- ES** Separadores

**THORACIC & LUNG SURGERY**  
[www.crimson-intl.com](http://www.crimson-intl.com)

**INTERNATIONAL**  
**CRIMSON™**

Scheme of dimensions

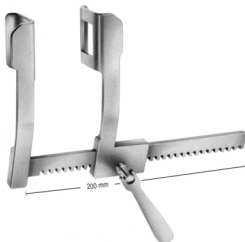

**FINOCHIETTO**

S/S	ALU	a	b	c
19.0440.01	19.7440.01	36mm	45mm	140mm

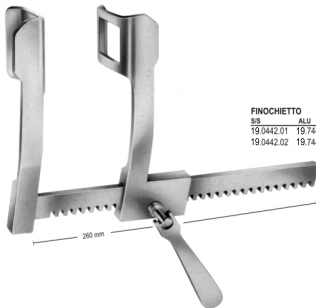

**FINOCHIETTO**

S/S	ALU	a	b	c
19.0442.01	19.7442.01	44mm	65mm	210mm
19.0442.02	19.7442.02	65mm	65mm	210mm

19.7442.02

**19-013**

# 19

- EN Rib Spreaders
- DE Rippensperrer
- ES Separadores

INTERNATIONAL  
**CRIMSON™**

THORACIC & LUNG SURGERY  
[www.crimson-intl.com](http://www.crimson-intl.com)

Scheme of dimensions

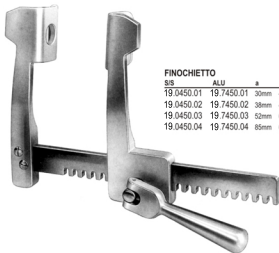

**FINOCHIETTO**

S/S	ALU	a	b	c
19.0450.01	19.7450.01	30mm	45mm	140mm
19.0450.02	19.7450.02	38mm	44mm	135mm
19.0450.03	19.7450.03	52mm	62mm	175mm
19.0450.04	19.7450.04	85mm	65mm	175mm

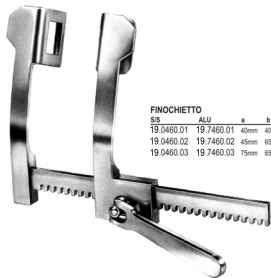

**FINOCHIETTO**

S/S	ALU	a	b	c
19.0460.01	19.7460.01	40mm	40mm	165mm
19.0460.02	19.7460.02	45mm	65mm	200mm
19.0460.03	19.7460.03	75mm	65mm	250mm

19.7460.03  
**19-014**

19

- EN** Rib Spreaders
- DE** Rippensperrer
- ES** Separadores

**THORACIC & LUNG SURGERY**  
[www.crimson-intl.com](http://www.crimson-intl.com)

INTERNATIONAL  
**CRIMSON™**

Scheme of dimensions

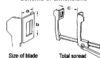

#### FINOCHIETTO

for adults

S/S	ALU	a	b	c
19.0470.01	19.7470.01	42mm	62mm	170mm
19.0470.02	19.7470.02	73mm	65mm	170mm



#### FINOCHIETTO

for adults, with suture separator

S/S	ALU	a	b	c
19.0472.01	19.7472.01	42mm	62mm	170mm



#### FINOCHIETTO

for adults, with 2 blades attached to each arm

S/S	ALU	a	b	c
19.0480.01	19.7480.01	10mm	15mm	120mm
19.0480.02	19.7480.02	14mm	14mm	120mm
19.0480.03	19.7480.03	14mm	20mm	120mm

19.7480.03

19-015

# 19

THORACIC & LUNG SURGERY  
www.crimson-intl.com

- EN Rib Spreaders With Interchangeable Blades
- DE Rippensperrer Mit Wechseln
- ES Separadores de costillas con valvas intercambiables

INTERNATIONAL  
**CRIMSON™**

Scheme of dimensions

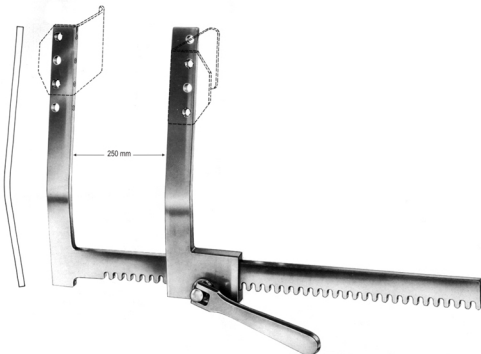
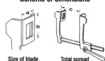

#### FINOCHIETTO

3 pairs of exchangeable blades

S/S	ALU	S/S	ALU
19.0490.00	19.7490.00	19.0491.00	19.7491.00
blades		blades	
19.0490.30	19.7490.30	19.0491.40	19.7491.40
19.0490.40	19.7490.40	19.0491.50	19.7491.50
19.0490.50	19.7490.50	19.0491.60	19.7491.60
frame only 150mm		frame only 250mm	
19.0490.01	19.7490.01	19.0491.01	19.7491.01

19.7491.01

19-016

- EN** Interchangeable Blades  
**DE** Wechselselven  
**ES** valves intercambiables



S/S Alu  
 19.0490.30 19.7490.30  
 30x30mm



S/S Alu  
 19.0490.40 19.7490.40  
 40x40mm



S/S Alu  
 19.0490.50 19.7490.50  
 50x50mm

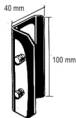

S/S Alu  
 19.0491.40 19.7491.40  
 40x100mm



S/S Alu  
 19.0491.50 19.7491.50  
 50x80mm



S/S Alu  
 19.0491.60 19.7491.60  
 60x60mm

## Optional Exchangeable Blades

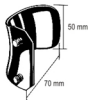

S/S Alu  
 19.0491.70 19.7491.70  
 70x50mm



S/S Alu  
 19.0491.80 19.7491.80  
 80x60mm

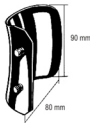

S/S Alu  
 19.0491.90 19.7491.90  
 80x80mm

19

- EN** Rib Spreaders
- DE** Rippensperrer
- ES** Separadores

**THORACIC & LUNG SURGERY**  
[www.crimson-intl.com](http://www.crimson-intl.com)

19.7502.03  
**19-018**

INTERNATIONAL  
**CRIMSON™**

Scheme of dimensions



**BURFORD**

for children  
 with 2 blades

S/S	ALU	a	b	c
19.0500.01	19.7500.01	30mm	42mm	130mm
		41mm	42mm	
19.0500.02	19.7500.02	34mm	42mm	135mm
		48mm	42mm	



**BURFORD**

for adults  
 with 2 pairs of blades

S/S	ALU	a	b	c
19.0502.01	19.7502.01	47mm	62mm	200mm
		65mm	62mm	
19.0502.02	19.7502.02	47mm	62mm	260mm
		65mm	62mm	
19.0502.03	19.7502.03	47mm	62mm	300mm
		65mm	62mm	

# 19

- EN** Rib Spreaders
- DE** Rippensperrer
- ES** Separadores

# INTERNATIONAL CRIMSON™

**THORACIC & LUNG SURGERY**  
[www.crimson-intl.com](http://www.crimson-intl.com)

Scheme of dimensions

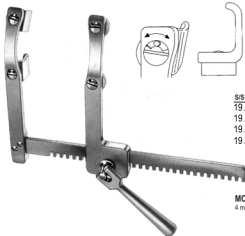

S/S	ALU	a	b	c
19.0510.01	19.7510.01	12mm	20mm	155mm
19.0510.02	19.7510.02	20mm	20mm	155mm
19.0510.03	19.7510.03	40mm	20mm	155mm
19.0510.04	19.7510.04	17mm	22mm	160mm

**MORSE-FAVALORO**  
4 movable blades for children

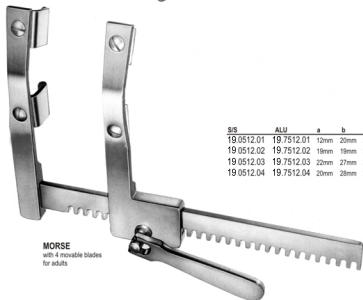

S/S	ALU	a	b	c
19.0512.01	19.7512.01	12mm	20mm	200mm
19.0512.02	19.7512.02	19mm	19mm	200mm
19.0512.03	19.7512.03	22mm	27mm	200mm
19.0512.04	19.7512.04	20mm	28mm	210mm

**MORSE**  
with 4 movable blades  
for adults

19.7512.04  
19-019



# 19

- EN Rib Spreaders
- DE Rippensperrer
- ES Separadores

THORACIC & LUNG SURGERY  
[www.crimson-intl.com](http://www.crimson-intl.com)

19.7530.10  
19-020

INTERNATIONAL  
**CRIMSON™**

Scheme of dimensions



#### MORSE STERNAL

S/S	ALU	a	b	c
19.0520.01	19.7520.01	30mm	35mm	200mm

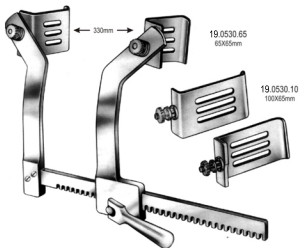

19.0530.65  
65X85mm

19.0530.10  
100X85mm

#### BRAASTAD

S/S	ALU
19.0530.01	19.7530.01
with 2 pairs of blades	
19.0530.65	19.7530.65
19.0530.10	19.7530.10

- EN** Rib Spreaders
- DE** Rippensperrer
- ES** Separadores

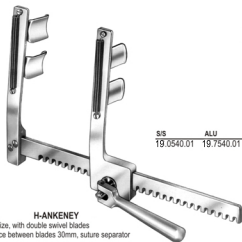

S/S	ALU	a	b	c
19.0540.01	19.7540.01	20mm	20mm	160mm

**H-ANKNEY**  
 child size, with double swivel blades  
 distance between blades 30mm, suture separator

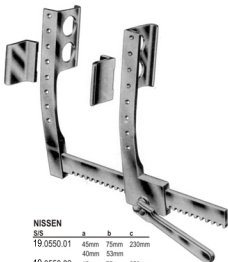

<b>NISSEN</b>				
S/S	a	b	c	
19.0550.01	45mm	75mm	230mm	
	40mm	53mm		
19.0550.02	45mm	75mm	250mm	
	40mm	53mm		

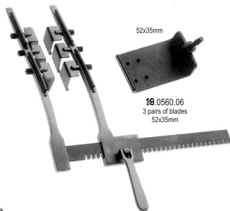

<b>ANKNEY</b>				
S/S	a	b	c	
19.0560.01	52mm	35mm	178mm	

52x35mm

**18.0560.06**  
 3 pairs of blades  
 52x35mm

19

- EN** Rib Spreaders
- DE** Rippensperrer
- ES** Separadores

INTERNATIONAL  
**CRIMSON™**

THORACIC & LUNG SURGERY  
[www.crimson-intl.com](http://www.crimson-intl.com)



**TUFFIER**

S/S	a	b	c
19.0570.14	32mm	19mm	110mm



**TUFFIER**

S/S	a	b	c
19.0572.17	43mm	53mm	130mm



**TUFFIER**

S/S	a	b	c
19.0574.16	50mm	45mm	165mm

19.0574.16

19-022

# 19

THORACIC & LUNG SURGERY  
[www.crimson-intl.com](http://www.crimson-intl.com)

- EN Rib Spreaders
- DE Rippensperrer
- ES Separadores

INTERNATIONAL  
**CRIMSON™**

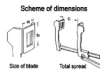

HAIGHT

S/S	a	b	c
19.0580.14	30mm	30mm	90mm

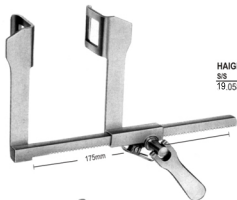

HAIGHT

S/S	a	b	c
19.0582.15	30mm	30mm	115mm



HERTZLER

S/S	a	b	c
19.0590.15	20mm	25mm	105mm

19.0590.15

19-023

# 19

- EN Rib Spreaders
- DE Rippensperrer
- ES Separadores

# INTERNATIONAL CRIMSON™

THORACIC & LUNG SURGERY  
[www.crimson-intl.com](http://www.crimson-intl.com)

Scheme of dimensions

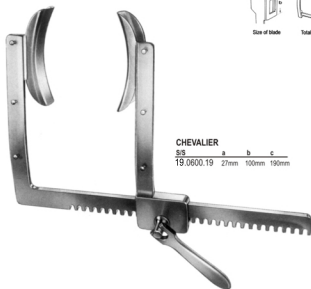

19.0610.02  
19-024

# 19

THORACIC & LUNG SURGERY  
[www.crimson-intl.com](http://www.crimson-intl.com)

19.0630.00

19-025

- EN Rib Spreaders
- DE Rippensperrer
- ES Separadores

INTERNATIONAL  
**CRIMSON™**

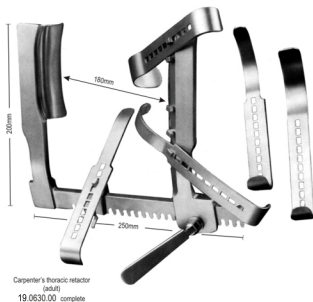
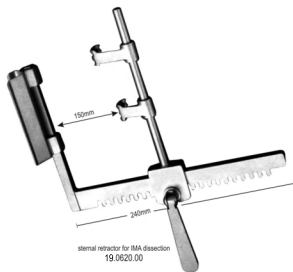

# 19

- EN Rib Spreaders
- DE Rippensperrer
- ES Separadores

INTERNATIONAL  
**CRIMSON™**

THORACIC & LUNG SURGERY  
[www.crimson-intl.com](http://www.crimson-intl.com)

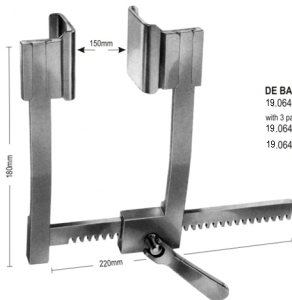

**DE BAKEY**

19.0640.00

with 3 pairs of blades

19.0640.01 / 19.0640.02 / 19.0640.03

19.0640.22 spreader only



Blades  
19.0640.01  
30 x 30 mm



Blades  
19.0640.02  
40 x 40 mm



Blades  
19.0640.03  
50 x 50 mm

19.0640.03

19-026

# 19

- EN Rib Spreaders
- DE Rippensperrer
- ES Separadores

INTERNATIONAL  
**CRIMSON™**

THORACIC & LUNG SURGERY  
[www.crimson-intl.com](http://www.crimson-intl.com)

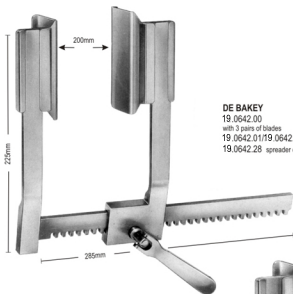

**DE BAKEY**  
19.0642.00  
with 3 pairs of blades  
19.0642.01/19.0642.02/19.0642.03  
19.0642.28 spreader only

blades  
19.0642.01  
60 x 60 mm

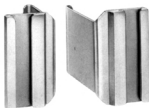

blades  
19.0642.02  
50 x 60 mm



blades  
19.0642.03  
40 x 100 mm



blades  
19.0642.04  
80 x 60 mm

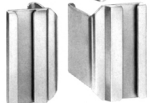

blades  
19.0642.05  
50 x 66 mm



19.0642.05  
19-027



# 19

- EN Rib Spreaders
- DE Rippensperrer
- ES Separadores

INTERNATIONAL  
**CRIMSON™**

THORACIC & LUNG SURGERY  
[www.crimson-intl.com](http://www.crimson-intl.com)

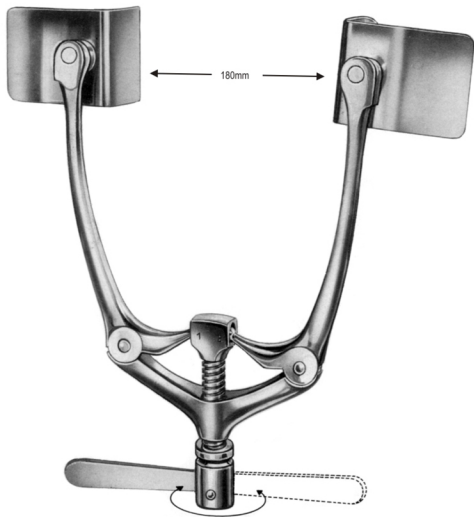

19.0650.00

19-028

**QUERVAIN**

19\_0650.00

35 X 50 X 180 mm

# 19

- EN Rib Spreaders
- DE Rippensperrer
- ES Separadores

THORACIC & LUNG SURGERY  
[www.crimson-intl.com](http://www.crimson-intl.com)

INTERNATIONAL  
**CRIMSON**™



19.0660.65

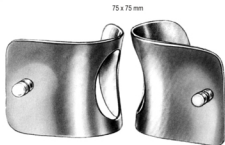

19.0660.75

- 19.0660.00 complete consisting of:
- 19.0660.01 retractor only
- 19.0660.65 1 pair blades 42x65mm
- 19.0660.75 1 pair blades 75x75mm

19.0660.75

19-029

# 19

THORACIC & LUNG SURGERY  
[www.crimson-intl.com](http://www.crimson-intl.com)

- EN Rib Contractors, Lung Spatula
- DE Rippenkontraktoren, Lungenspatel
- ES Aproximadores para costillas, espátula pulmonar

INTERNATIONAL  
**CRIMSON**™



**ALLISON**  
19.0690.25 25.0cm  
19.0690.30 30.0cm  
19.0690.32 32.0cm



19.0700.26  
26.0cm



**CRAFOORD**  
19.0710.28  
28.0cm



**BAILEY-BABY** 19.0720.14 14.0cm  
**BAILEY** 19.0722.16 16.0cm  
19.0722.20 20.0cm



**BAILEY-GIBBON**  
19.0724.16 16.0cm  
19.0724.20 20.0cm



19.0730.19  
19.0cm



**LEMMON**  
19.0740.14 14.5cm  
19.0740.18 18.0cm

19.0740.18  
**19-030**

# 19

THORACIC & LUNG SURGERY  
[www.crimson-intl.com](http://www.crimson-intl.com)

- EN Bronchus Forceps, Ligature Forceps
- DE Bronchusklemmen, Ligaturklemmen
- ES Pinzas clamps bronquiales, pinzas para ligaduras

INTERNATIONAL  
**CRIMSON**™

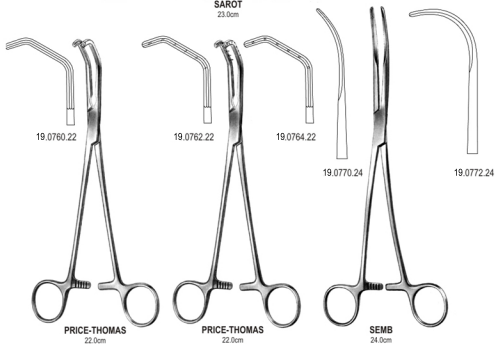

19.0772.24

19-031